

High Pressure Fluid Regulators

309475F



Important Safety Instructions

Read all warnings and instructions in this manual.
Save these instructions.





Contents

List of Models	3	Maintenance	15
Introduction	6	Parts	16
Installation	8	Technical Data	24
Operation	13	Accessory Gauges	25
Flush Before First Use	13	Flow Rate Data	26
Pressure Relief Procedure	13	Mounting Dimensions	26
Adjusting the Regulator	13	Graco Warranty	28
Troubleshooting	14	Graco Information	28

Manual Conventions

Warning

**WARNING**

A warning alerts you to the possibility of serious injury or death if you do not follow the instructions.

Symbols, such as fire and explosion (shown above), alert you to a specific hazard and direct you to read the indicated hazard warnings (pages 4-5) for detailed information.

Caution

CAUTION

A caution alerts you to the possibility of damage to or destruction of equipment if you do not follow the instructions.

List of Models

Part No.	Series	Model	Type	Maximum Fluid Inlet Pressure	Regulated Pressure Range
233760 234266	B B	P60-VP DN7 P60-VP DN7 npt	Pneumatic	5000 psi (36 MPa, 360 bar)	70-900 psi (0.5-6 MPa, 5-60 bar)
233767 234264	B B	P200-VM P200-VM npt	Mechanical	5000 psi (36 MPa, 360 bar)	1300-3000 psi (9-20 MPa, 90-200 bar)
233768 234265	B B	P200-VM P200-VM npt	Mechanical	5000 psi (36 MPa, 360 bar)	1300-4000 psi (9-27 MPa, 90-270 bar)
233769 234270	B B	P150-VP DN7 P150-VP DN7 npt	Pneumatic	5000 psi (36 MPa, 360 bar)	300-2000 psi (2-15 MPa, 20-150 bar)
233770 234271	B B	P320-VP DN7 P320-VP DN7 npt	Pneumatic	5000 psi (36 MPa, 360 bar)	600-4600 psi (4-32 MPa, 40-320 bar)
233813 234259	B B	P250-VP P250-VP npt	Pneumatic	5000 psi (36 MPa, 360 bar)	600-3600 psi (4-25 MPa, 40-250 bar)
233814 234260	B B	P100-VM P100-VM npt	Mechanical	2600 psi (18 MPa, 180 bar)	600-1500 psi (4-10 MPa, 40-100 bar)

Back Pressure Regulators

Part No.	Series	Model	Type	Maximum Permanent Supply Pressure	Regulated Pressure Range
233771 234268	B B	P100-RM P100-RM npt	Mechanical, back pressure	2500 psi (17 MPa, 170 bar)	600-1500 psi (4-10 MPa, 40-100 bar)
233772 234269	B B	P200-RM P200-RM npt	Mechanical, back pressure	3400 psi (23.5 MPa, 235 bar)	1300-3000 psi (9-20 MPa, 90-200 bar)

Key to Model Designation

Pressure regulation valve e.g.

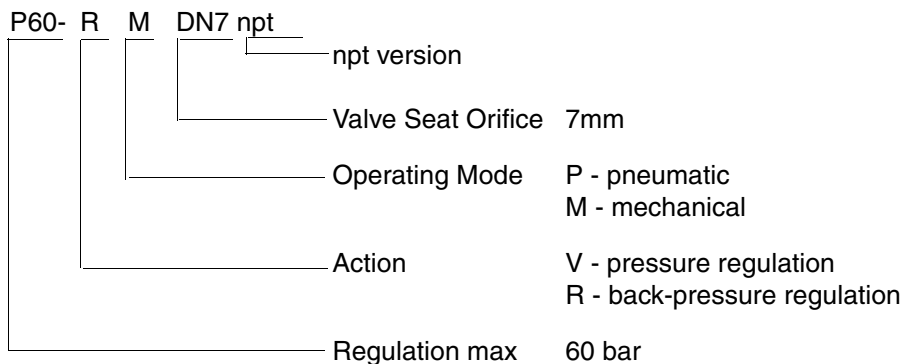

 **WARNING**



EQUIPMENT MISUSE HAZARD

Equipment misuse can cause the equipment to rupture or malfunction and result in serious injury.

- This equipment is for professional use only.
- Read all instruction manuals, tags, and labels before operating the equipment.
- Use the equipment only for its intended purpose. If you are not sure, call your Graco distributor.
- Do not alter or modify this equipment. Use only genuine Graco parts and accessories.
- Check equipment daily. Repair or replace worn or damaged parts immediately.
- Do not exceed the maximum working pressure of the lowest rated system component. Refer to the **Technical Data** on page 24 for the maximum working pressure of this equipment.
- Use fluids and solvents which are compatible with the equipment wetted parts. Refer to the **Technical Data** section of all equipment manuals. Read the fluid and solvent manufacturer's warnings.
- Route hoses away from traffic areas, sharp edges, moving parts, and hot surfaces. Do not expose Graco hoses to temperatures above 180°F (82°C) or below -40°F (-40°C).
- Wear hearing protection when operating this equipment.
- Never use 1,1, 1-trichloroethane, methylene chloride, other halogenated hydrocarbon solvents or fluids containing such solvents in pressurized aluminum equipment. Such use could result in a chemical reaction, with the possibility of explosion.
- Comply with all applicable local, state, and national fire, electrical, and safety regulations.

WARNING
**SKIN INJECTION HAZARD**

Spray from the gun, hose leaks, or ruptured components can inject fluid into your body and cause an extremely serious injury, including the need for amputation. Splashing fluid in the eyes or on the skin can also cause serious injury.

- Fluid injected into the skin might look like just a cut, but is a serious injury. **Get immediate surgical treatment.**
- Do not point the gun at anyone or at any part of the body. Do not put your hand or fingers over the spray tip. Do not stop or deflect fluid leaks with your hand, body, glove, or rag.
- Never spray without the tip guard in place.
- Follow the steps under **Pressure Relief Procedure**, page 13, when you stop spraying and before cleaning, checking, or repairing equipment.
- Check the hoses and couplings daily. Replace worn, damaged, or loose parts immediately. Permanently coupled hoses cannot be repaired; replace the entire hose.
- Tighten all fluid connections before each use.

**TOXIC FLUID HAZARD**

Hazardous fluid or toxic fumes can cause serious injury or death if splashed in the eyes or on the skin, inhaled, or swallowed.

- Know the specific hazards of the fluid you are using. Read the fluid manufacturer's warnings.
- Store hazardous fluid in an approved container. Dispose of hazardous fluid according to all local, state and national guidelines.
- Always wear protective eyewear, gloves, clothing and respirator as recommended by the fluid and solvent manufacturer.

Introduction

A fluid pressure regulator is used in air-assisted spray systems to ensure accurate, positive control of fluid pressure to a spray gun, dispensing valve, or atomizing head.

A regulator installed at a circulating line take-off or pump reduces main line pressure to maintain the desired fluid pressure to the spray gun, dispensing valve, or atomizing head.

Models 233771, 233772, 234268 and 234269 (FIG. 1.) are mechanically operated back pressure regulators that limit the supply pressure to a set value by opening an outlet and guiding back excess material when the predetermined pressure has been achieved. These valves are used in circulating systems.

Models 233767, 233814, 233768, 234260, 234264, and 234265 (FIG. 2.) are mechanically operated fluid pressure regulators designed primarily for use with low to medium viscosity fluids.

Models 233760, 233769, 233770, 233813, 234259, 234266, 234270, and 234271 (FIG. 3.) are pneumatically operated fluid pressure regulators designed primarily for use with highly viscous coatings.

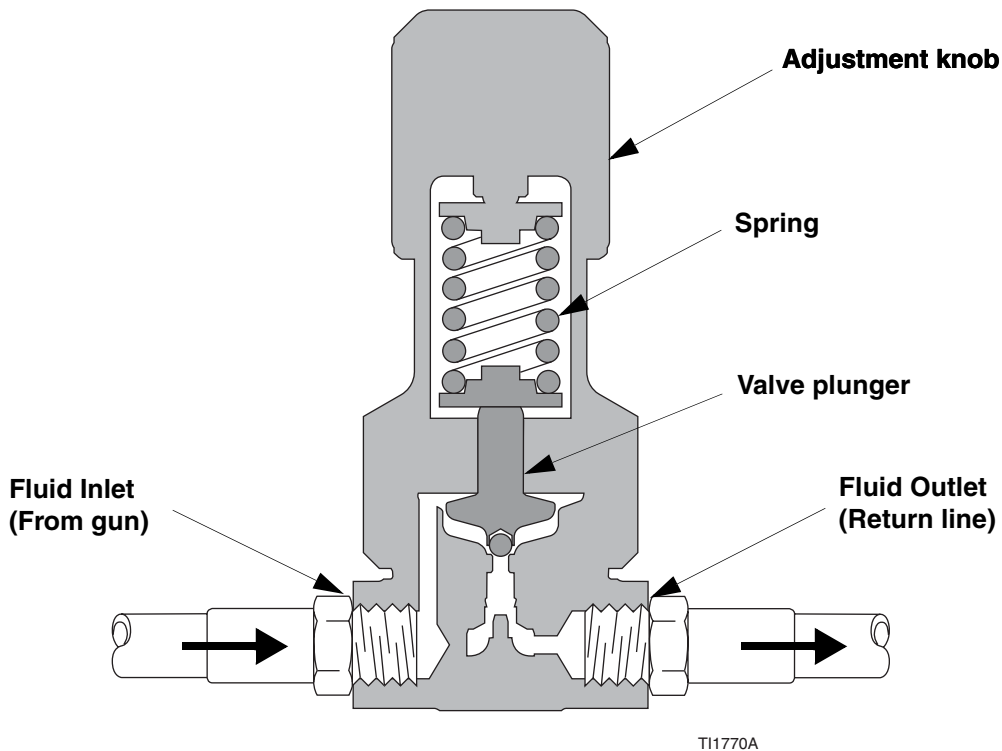
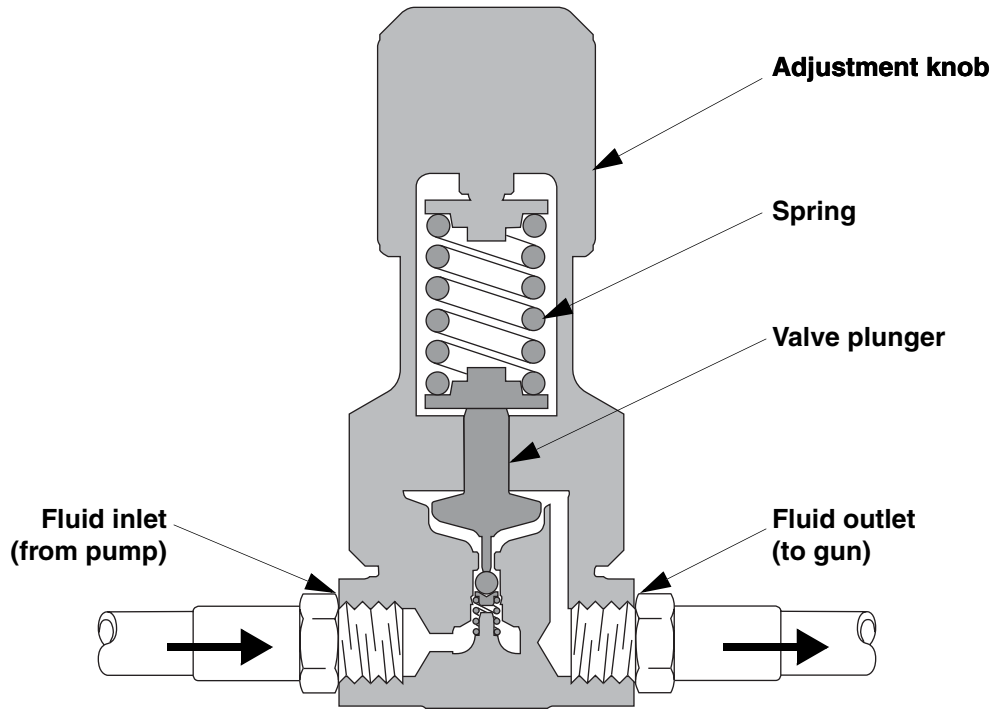
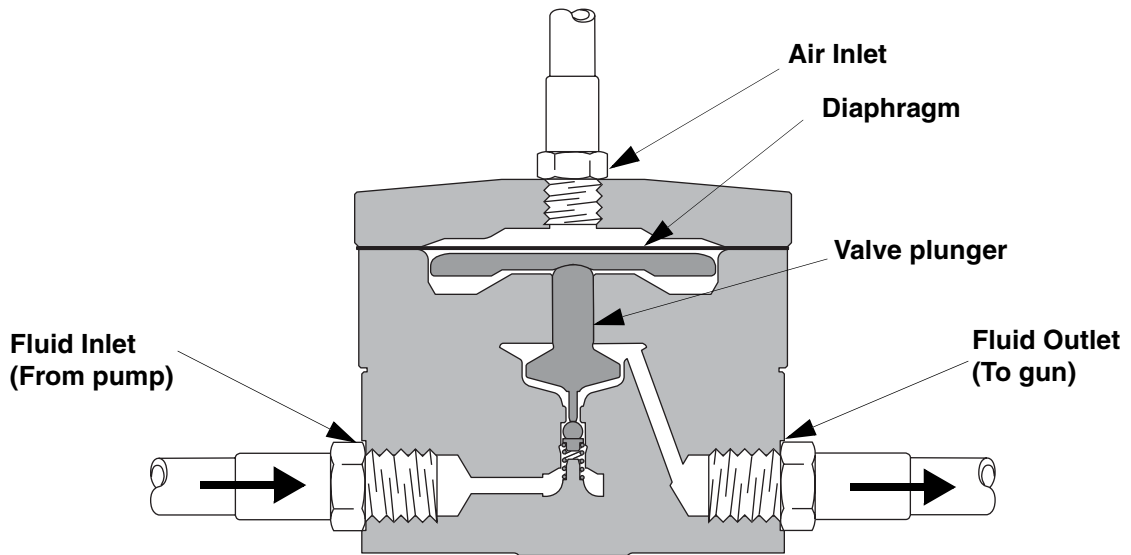

Fig. 1. Cutaway of Mechanical Back Pressure Regulator



T11769A

Fig. 2. Cutaway of Mechanical Fluid Pressure Regulator



T11774A

Fig. 3. Cutaway of Pneumatic Fluid Pressure Regulator

Installation

1. Install one regulator for each spray gun.
2. Apply thread sealant to connections as necessary.
3. Make sure that the direction of fluid flow agrees with the flow direction markings on the regulator body.
 - a. Install a fluid pressure regulator *upstream* of the gun: Connect the fluid line from the pump to the inlet of the fluid regulator. Connect the fluid line to the gun to the regulator's outlet.
 - b. Install a back pressure regulator *downstream* of the gun. Connect the fluid return line from the gun to the inlet of the back pressure regulator. Connect the fluid return line to the pump to the regulator's outlet.
4. Flush and test the entire system.

FIG. 4., FIG. 5., and FIG. 6. show possible configurations for installing a system. They do not depict actual system designs. Consult your Graco distributor for assistance in designing a system that meets your specific requirements.

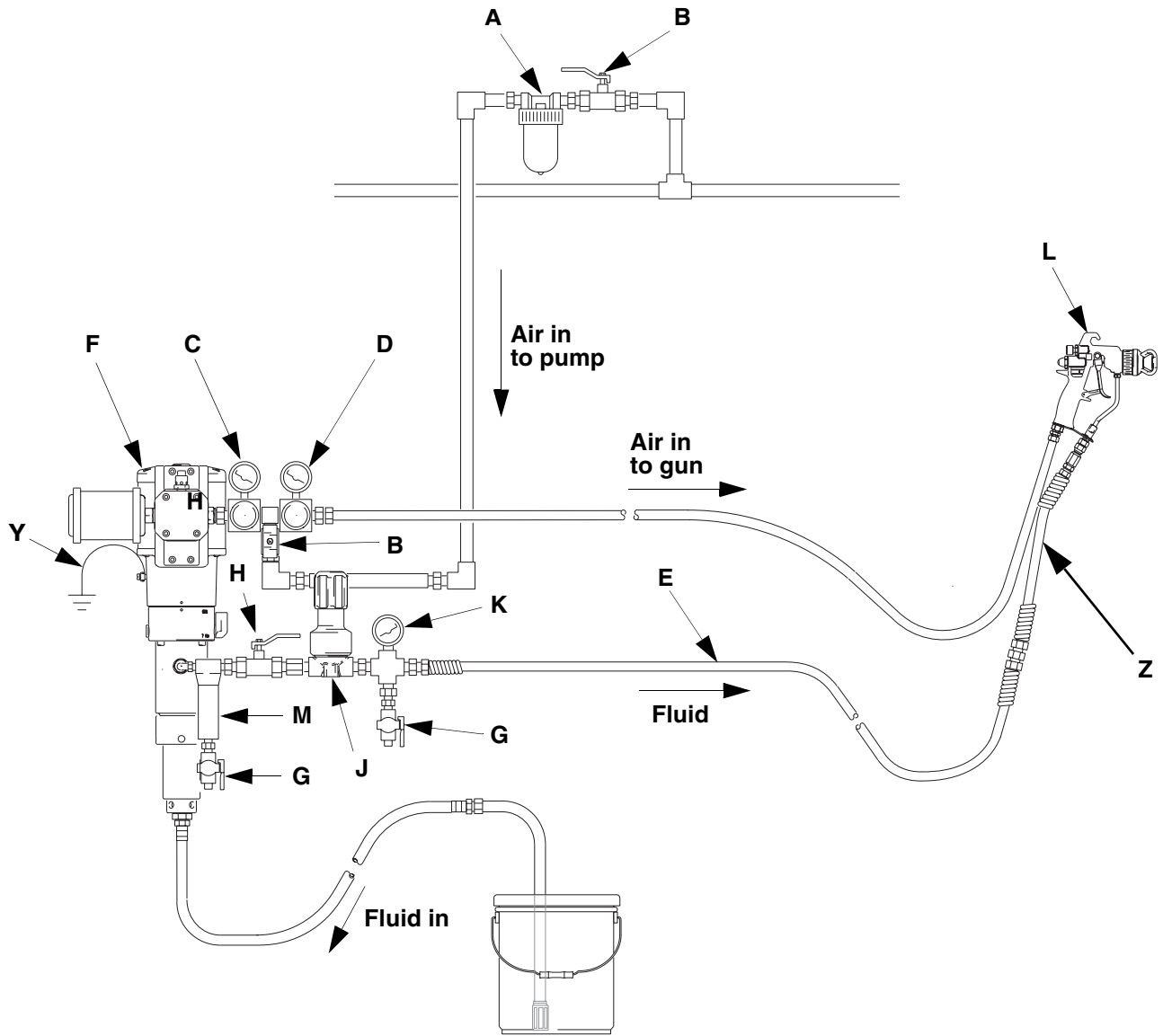

TI1763C

Fig. 4. High pressure, non-circulating system, mechanical fluid regulator

Key

A	Air line filter
B	Bleed-type air shut-off valve
C	Pump air regulator
D	Gun air regulator
E	Fluid hose
F	Pump

G	Fluid drain valve
H	Fluid shut-off valve
J	Mechanical fluid pressure regulator
K	Fluid pressure gauge
L	Air-assisted spray gun
M	Fluid filter
Y	Pump ground wire
Z	Whip hose

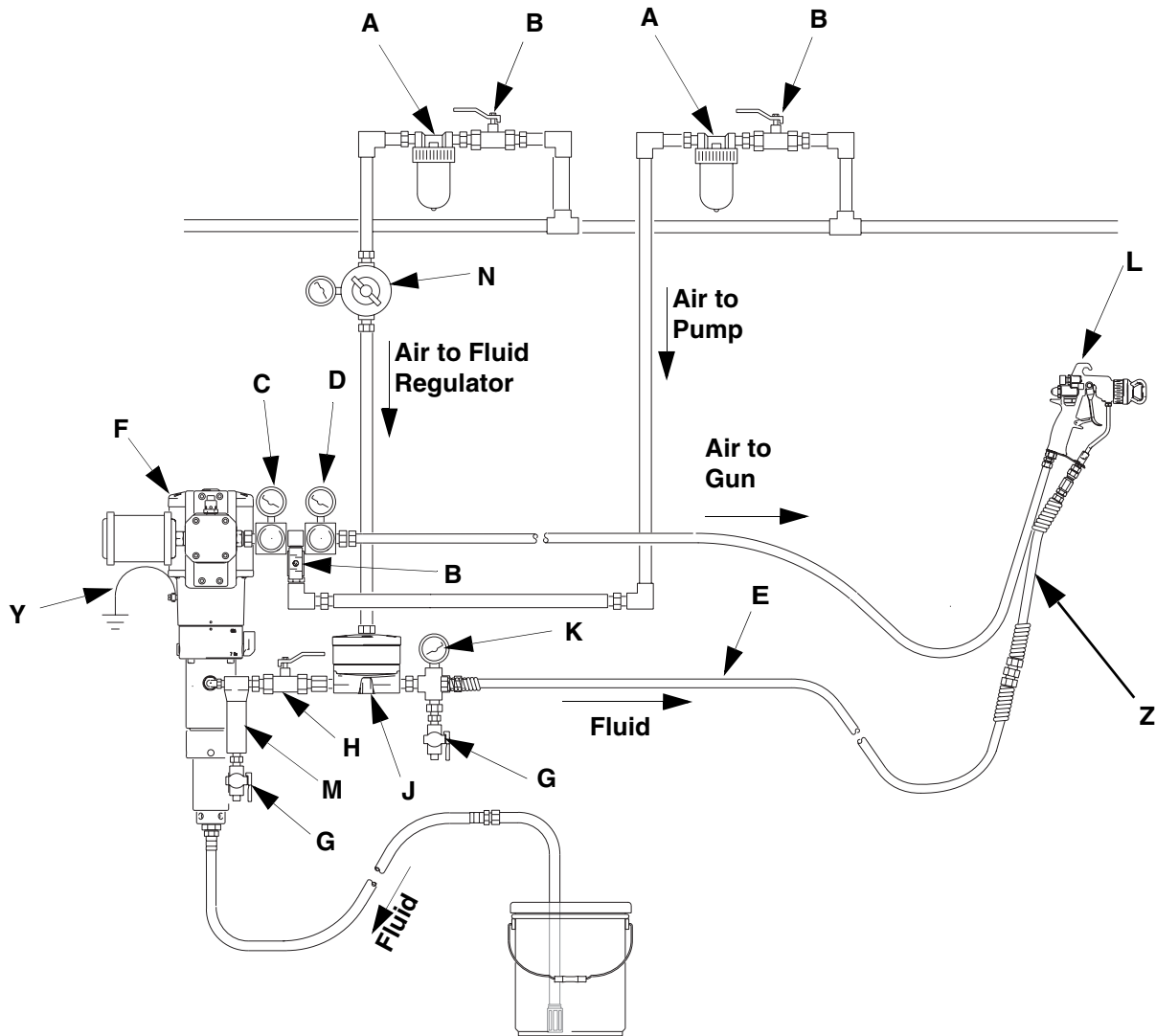

T11764C

Fig. 5. High pressure, non-circulating system, pneumatic fluid regulator

Key

A	Air line filter
B	Bleed-type air shut-off valve
C	Pump air regulator
D	Gun air regulator
E	Fluid hose
F	Pump
G	Fluid drain valve
H	Fluid shut-off valve

J	Pneumatic fluid regulator
K	Fluid pressure gauge
L	Gun
M	Fluid filter
N	Air regulator to operate/adjust fluid regulator
Y	Pump ground wire
Z	Whip hose

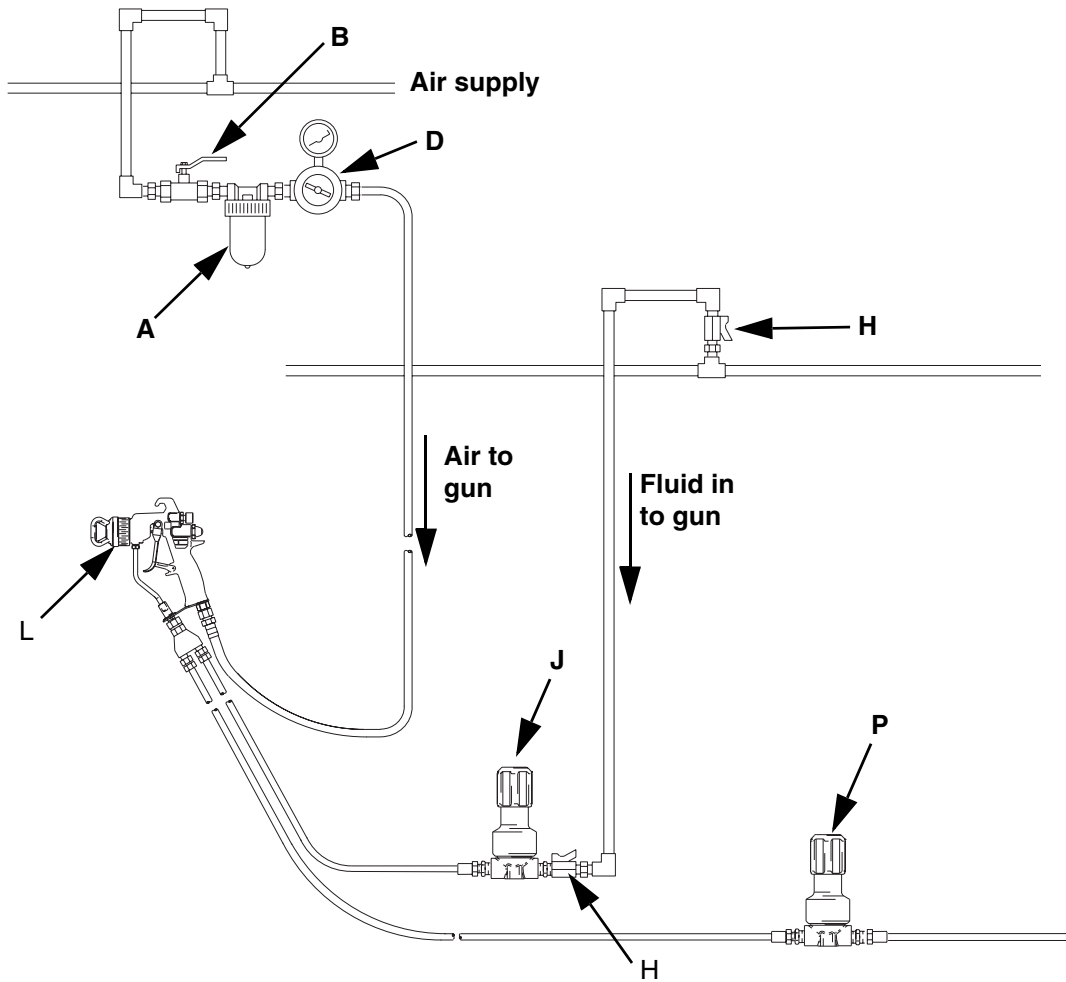

T11765A

Fig. 6. High Pressure circulating system mechanical fluid regulator and back pressure regulator
Key

A	Air line filter
B	Bleed-type air shut-off valve
D	Pump air regulator
H	Fluid shut-off valve

J	Mechanical fluid regulator
L	Gun
P	Mechanical back pressure regulator

Operation

Flush Before First Use

Your pressure regulator has been tested in the factory with an anti-corrosion liquid. Before using the regulator, thoroughly flush the system with a solvent to remove residue of this liquid as well as any contaminants that have been introduced during assembly of the system.

Pressure Relief Procedure

WARNING



The system pressure must be manually relieved to prevent the system from starting or spraying accidentally. To reduce the risk of an injury from accidental spray from the gun, splashing fluid, or moving parts, follow the **Pressure Relief Procedure** whenever you:

- are instructed to relieve the pressure
- stop spraying
- check or service any of the system equipment
- or install or clean the spray tip.

1. Lock the gun trigger safety.
2. Close the bleed-type master air valve (required in your system).
3. Unlock the gun trigger safety.
4. Hold a metal part of the gun firmly to the side of a grounded metal pail and trigger the gun to relieve pressure.
5. Lock the gun trigger safety.
6. Open the drain valve (required on your system), with a container ready to catch the drainage.
7. Leave the drain valve open until you are ready to spray again.

If you suspect that the spray tip or hose is completely clogged or that pressure has not been fully relieved after performing steps 1 through 7, very slowly loosen the tip guard retaining nut or hose end coupling and relieve pressure gradually. Then loosen completely and clear the tip or hose.

Adjusting the Regulator

The fluid pressure regulator controls pressure downstream from its outlet. The inlet fluid pressure should always be higher than the outlet fluid pressure.

If you are using an accessory fluid pressure gauge, trigger the spray gun to relieve pressure in the line when reducing the pressure, to ensure a correct gauge reading.

Adjust the pump air pressure and the fluid pressure regulator for the best spraying combination.

In a circulating system, the back pressure valve controls the fluid pressure upstream of its inlet in the same way.

Mechanical Regulator

1. Back out the knob until there is no spring pressure.
2. Turn on the fluid supply, to admit fluid to the regulator.
3. Turn the knob clockwise to adjust fluid pressure to the desired level.

Pneumatic Regulator

1. With the fluid supply shut off, turn on the air pressure to the regulator.
2. Turn on the fluid supply, to admit fluid to the regulator.
3. Increase the fluid inlet pressure. When the fluid outlet pressure is at the desired level, shut off the air to the fluid regulator.

Troubleshooting

Relieve the pressure (page 13) before checking or repairing the equipment.

To repair the regulator, refer to page 15.

Problem	Cause	Solution
Drop in fluid outlet pressure.	Ruptured diaphragm (17) (pneumatic regulators only).	Replace diaphragm.
	Air escaping (pneumatic regulators only).	Check air hose and connections. Replace packings (13).
	Worn packings.	Replace packings (13).
Fluid outlet pressure increases to level of fluid inlet pressure.	Valve ball (8) and seat (4) are worn or stuck open.	Clean ball and seat. Replace worn or damaged parts.
Fluid leaking from upper housing.	Ruptured diaphragm (17) (pneumatic regulators only).	Replace diaphragm.
	Worn packings.	Replace packings (13).

Maintenance

Flushing

WARNING



The system pressure must be manually relieved to prevent the system from starting or spraying accidentally. Fluid under high pressure can be injected through the skin and cause serious injury. To reduce the risk of an injury from fluid injection, splashing fluid, or moving parts, follow the **Pressure Relief Procedure** whenever you:

- are instructed to relieve the pressure
- stop spraying
- check or service any of the system equipment
- or install or clean the spray tip.

1. Relieve the pressure.
2. Remove the spray tip. Clean the tip and set it aside.
3. Supply solvent to the pump. Start the pump. Use the lowest possible fluid pressure when flushing.
4. Flush the gun, spraying into a grounded metal container until clean solvent comes from the gun.
5. Relieve the pressure.
6. Reinstall the spray tip.

Do not allow paint or solvent to sit in the system for extended periods. Fluid could dry on the plunger and cause leakage at the plunger packings. If leakage occurs, disassemble and clean the regulator.

Cleaning and Repair

When changing fluids or colors, the regulator should be disassembled and cleaned. Regular cleaning and inspection of the internal parts is necessary to keep the fluid regulator working properly.

1. Relieve all air and fluid pressure in the system.
2. Remove the regulator from the system.
3. Disassemble the regulator (see the parts drawings on pages 16 through 22).
4. Clean and inspect all parts.

CAUTION

Be very careful when handling the carbide balls and seats. Damage will cause poor operation and leakage.

5. Inspect the diaphragm, packings, o-rings, and seals for wear. Check the ball and seat for nicks, wear, or other damage.
6. Lubricate packings, o-rings and seals when reassembling the regulator.
7. Torque as specified on the parts drawings on pages 16 through 22

Parts

Mechanical Regulators

Part Nos. 233767 (shown), 233768, 233814, 234260, 234264, and 234265

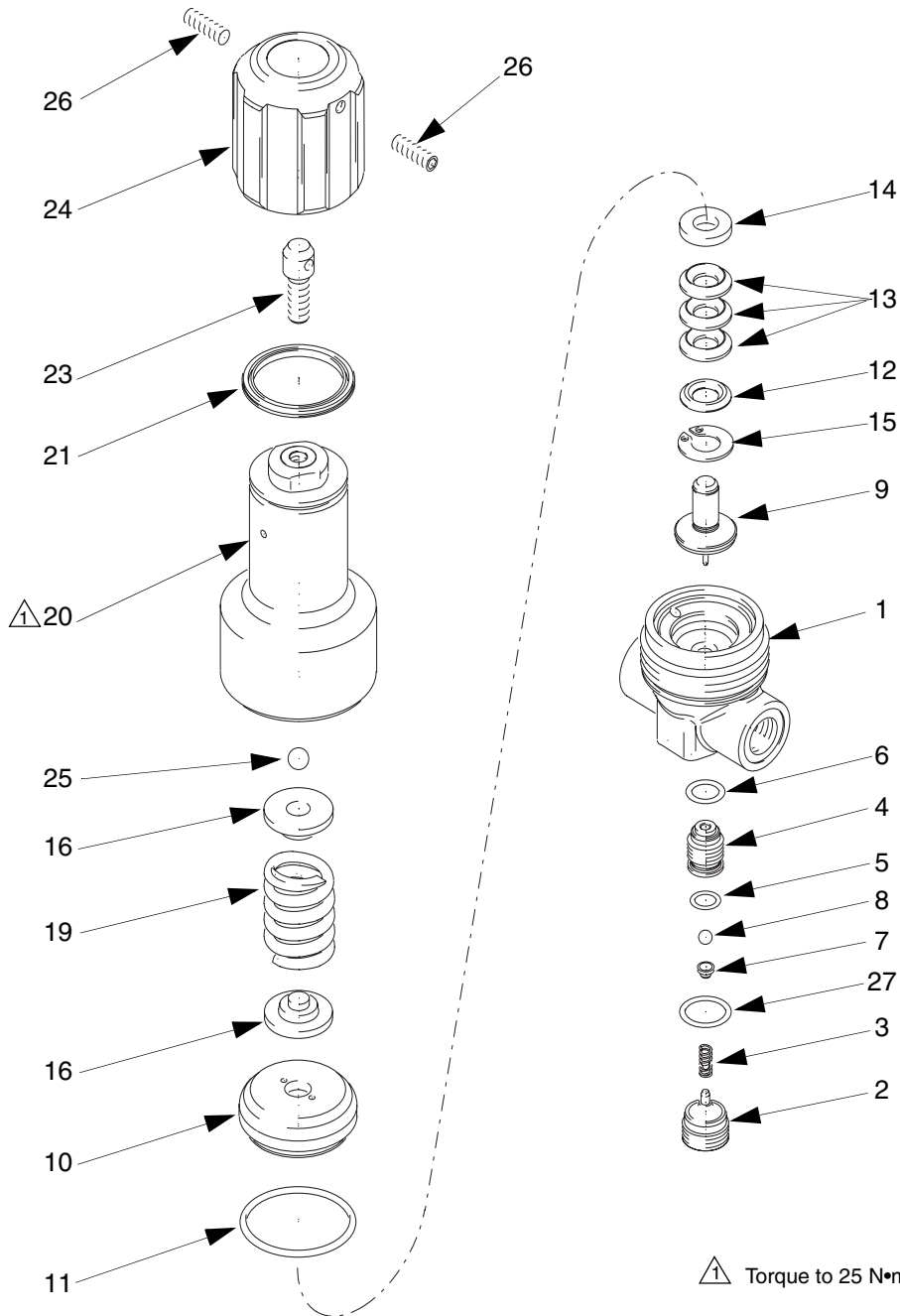

Mechanical Regulators**Part Nos. 233767 (shown), 233768, 233814, 234260, 234264, and 234265**

Ref. No.	Part No.	Description	Qty	Ref. No.	Part No.	Description	Qty
				14	15A149	GLAND, female	1
1		HOUSING, lower	1	15	117125	RING, retaining, internal	1
		HOUSING, lower (for npt version)	1	16	15A178	PLATE, spring	2
2	15A238	PLUG, screw	1	19	117093	SPRING, compression; for 233814 and 234260	1
3	117089	SPRING, compression	1		117094	SPRING, compression; for 233767, 233768, 234264, and 234265	1
4	245367	SEAT, valve	1		117088	SPRING, compression; for 233768, 234265	1
5	15Y030	O-RING	1		20	15A192	HOUSING, upper
6	15Y031	O-RING	1	21	117103	SEAL, flat	1
7	15A206	SUPPORT, ball	1	23	15A240	SCREW, custom	1
8	117104	BALL, 5 mm	1	24	15A203	CAP	1
9	245374	PLUNGER, valve	1	25	117108	BALL, 8 mm	1
10	15A217	HOUSING, packing	1	26	117098	SCREW, set; M6x20	2
11	117112	O-RING, slit	1	27	15Y029	O-RING	1
12	15A223	GLAND, male	1				
13	15A142	PACKING	3				

Mechanical Back Pressure Regulators
Part Nos. 233771, 233772, 234268, and 234269 (shown)

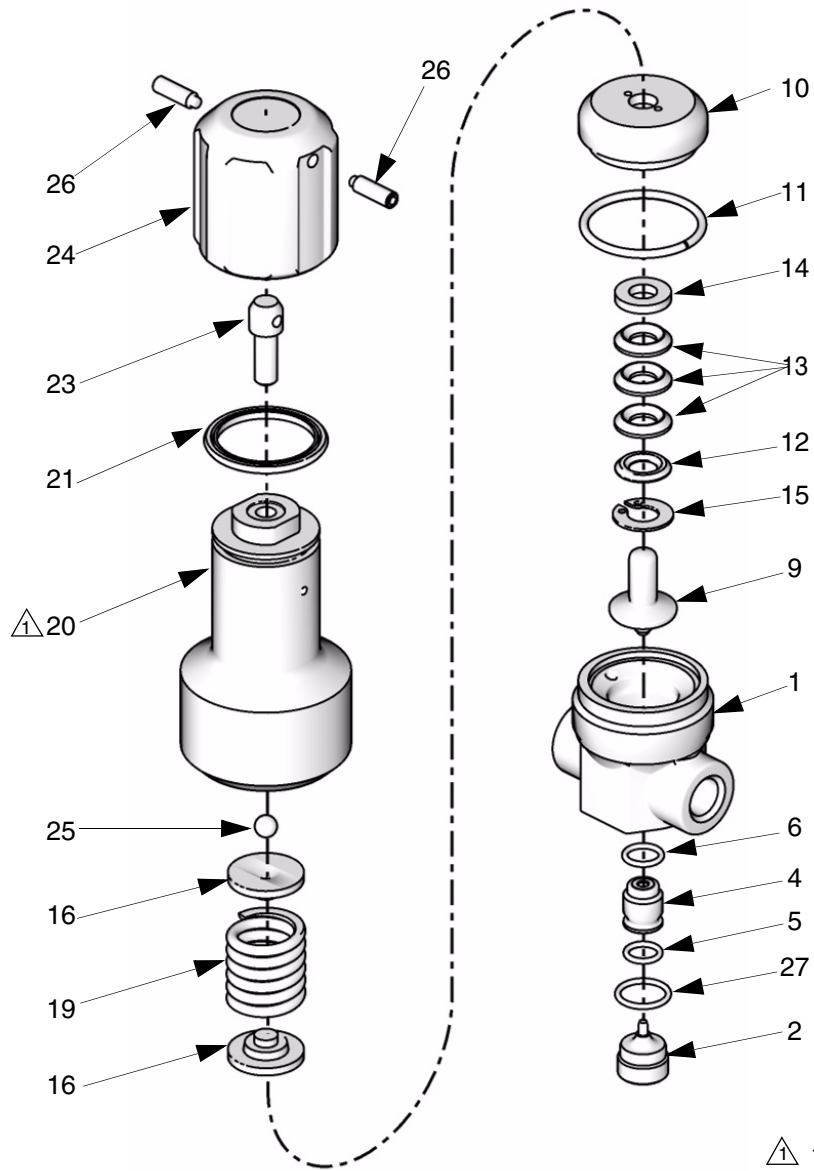

Mechanical Back Pressure Regulators
Part Nos. 233771, 233772, 234268, and 234269

Ref. No.	Part No.	Description	Qty	Ref. No.	Part No.	Description	Qty
				15	117125	RING, retaining, internal	1
1		HOUSING, lower	1	16	15A178	PLATE, spring	2
		HOUSING, lower (for npt version)	1	19	117093	SPRING, compression; for 233771 and 234268	1
2	15A238	PLUG, screw	1		117094	SPRING, compression; for 233772 and 234269	1
4	245367	SEAT, valve	1				
5	15Y030	O-RING	1	20	15A192	HOUSING, upper	1
6	15Y031	O-RING	1	21	117103	SEAL, flat	1
9	245376	PLUNGER, valve	1	23	15A240	SCREW, custom	1
10	15A217	HOUSING, packing	1	24	15A203	CAP	1
11	117112	O-RING, slit	1	25	117108	BALL, 8 mm	1
12	15A223	GLAND, male	1	26	117098	SCREW, set; M6x20	2
13	15A142	PACKING	3	27	15Y029	O-RING	1
14	15A149	GLAND, female	1				

Pneumatic Regulators
Part No. 233813 and 234259

Ref. No.	Part No.	Description	Qty	Ref. No.	Part No.	Description	Qty
1		HOUSING, lower	1	12	15A223	GLAND, male	1
		HOUSING, lower (npt version only)	1	13	15A142	PACKING	3
2	15A238	PLUG, screw	1	14	15A149	GLAND, female	1
3	117089	SPRING, compression	1	15	117125	RING, retaining, internal	1
4	245367	SEAT, valve	1	16	15A212	PLATE, diaphragm	1
5	15Y030	O-RING	1	17	15A180	DIAPHRAGM	1
6	15Y031	O-RING	1	18	15A218	HOUSING, diaphragm	1
7	15A206	SUPPORT, ball	1	20	15A145	COVER, diaphragm	1
8	117104	BALL, 5mm, carbide	1	26	117128	SCREW, shcs; M8x50	6
9	245375	PLUNGER, valve	1	27	15Y029	O-RING	1
11	15Y033	O-RING	1	29	15C332	FITTING, (npt models only)	1
				30	15C333	WASHER, (npt models only)	1

Pneumatic Regulators

Part Nos. 233760 (shown), 233769, 233770, 234266, 234270, and 234271

 Torque to 10 N•m (7.5 ft-lb).

 Torque to 12 N•m (8.8 ft-lb).

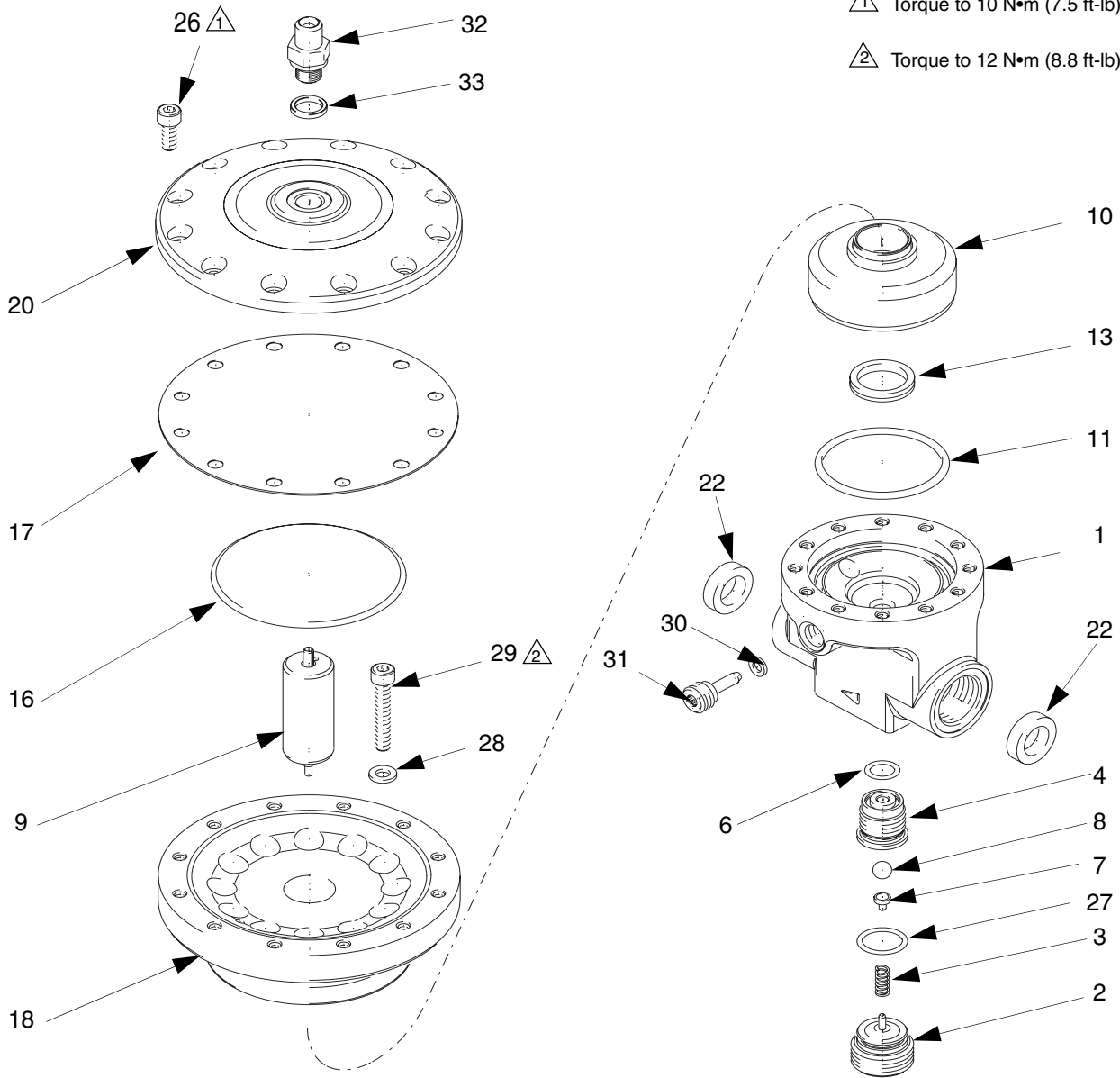

T11745A

Pneumatic Regulators**Part Nos. 233760 (shown), 233769, 233770, 234266, 234270, and 234271**

Ref. No.	Part No.	Description	Qty	Ref. No.	Part No.	Description	Qty
				18	15A209	HOUSING, diaphragm; for 233760 and 234266	1
1	15A187	HOUSING, lower	1		15A210	HOUSING, diaphragm; for 233769 and 234270	1
	15C298	HOUSING, lower (for npt version)	1		15A211	HOUSING, diaphragm; for 233770 and 234271	1
2	15A239	PLUG, screw	1				
3	117091	SPRING, compression	1	20	15A146	COVER, diaphragm; for 233760 and 234266	1
4	245370	SEAT, valve	1		15A147	COVER, diaphragm; for 233769 and 234270	1
6	15Y031	O-RING	1		15A148	COVER, diaphragm; for 233770 and 234271	1
7	15A207	SUPPORT, ball	1				
8	117107	BALL, 8mm, carbide	1				
9	245377	PLUNGER, valve; for 233760, 234266,	1	22	15A220	RING (for non-npt models only)	2
	245379	PLUNGER, valve; for 233769, 233770, 234270, and 234271	1	26	117028	SCREW, shcs; M6x16	12
10	245364	HOUSING, plunger	1	27	15Y032	O-RING	1
11	15Y034	O-RING	1	28	117018	WASHER	12
13	117111	SEAL, rod	1	29	117030	SCREW, shcs; M6x40	12
16	15A213	PLATE, diaphragm; for 233760 and 234266	1	30	117086	WASHER	1
	15A214	PLATE, diaphragm; for 233769 and 234270	1	31	117100	PLUG, threaded	1
	15A215	PLATE, diaphragm; for 233770 and 234271	1	32	15C332	FITTING (npt models only)	1
17	15A181	DIAPHRAGM; for 233760 and 234266	1	33	15C333	WASHER (npt models only)	1
	15A182	DIAPHRAGM; for 233769 and 234270	1				
	15A183	DIAPHRAGM; for 233770 and 234271	1				

Technical Data

Category	Data
Maximum Fluid Inlet Pressure (Fluid Pressure Regulators)	233814, 234260: 2600 psi (18 MPa, 180 bar) 233760, 233767, 233768, 233769, 233770, 233813, 234259, 234264, 234265, 234266, 234270, and 234271: 5000 psi (36 MPa, 360 bar)
Maximum Permanent Supply Pressure (Back Pressure Regulators)	233771, 234268: 2500 psi (17 MPa, 170 bar) 233772, 234269: 3400 psi (23.5 MPa, 235 bar)
Pressure Range	233760, 234266: 70-900 psi (0.5-6 MPa, 5-60 bar) 233767, 233772, 234264, 234269: 1300-3000 psi (9-20 MPa, 90-200 bar) 233768, 234265: 1300-4000 psi (9-27 MPa, 90-270 bar) 233769, 234270: 300-2000 psi (2-15 MPa, 20-150 bar) 233770, 234271: 600-4600 psi (4-32 MPa, 40-320 bar) 233771, 233814, 234268, 234260: 600-1500 psi (4-10 MPa, 40-100 bar) 233813, 234259: 600-3600 psi (4-25 MPa, 40-250 bar)
Maximum Operating Air Pressure (Pneumatic Regulators Only)	233760, 233770, 233813, 234259, 234266, 234271: : 85 psi (0.6 MPa, 6 bar) 233769, 234270: 75 psi (0.5 MPa, 5 bar)
Maximum Flow Rate	See chart on page 26.
Temperature Range	233767, 233768, 233771, 233772, 233813, 233814, 234259, 234260, 234264, 234265, 234268, 234269: 32-194°F (0-90°C) 233760, 233769, 233770, 234266, 234270, 234271: 50-176°F (10-80°C)
Fluid inlet and outlet	233767, 233768, 233771, 233772, 233813, 233814, : 3/8 BSPP(F) 234259, 234260, 234264, 234265, 234268, 234269: 3/8 npt(F) 233760, 233769, 233770: 3/4 BSPP(F) 234266, 234270, 234271: 3/4 npt(F)
Air inlet	233760, 233769, 233770, 233813: 1/4 BSPP(F) 234259, 234266, 234270, 234271: 1/4 npt(M)
*Gauge port	233760, 233769, 233770, 234266, 234270, 234271: 1/4 BSPP(F)
Wetted Parts	233767, 233768, 233771, 233772, 233813, 233814, 234259, 234260, 234264, 234265, 234268, 234269: Stainless steel, tungsten carbide, PTFE, chemically resistant fluoroelastomer 233760, 233769, 233770, 234266, 234270, 234271: UHMWPE, Stainless steel, acetal, tungsten carbide, PTFE, chemically resistant fluoroelastomer

*Accessory Gauges Available

Accessory Gauges

Model	Gauge
233760	118340
234266	118340
233769	118341
234270	118341
234770	118341
234271	118341

Flow Rate Data

Maximum fluid flow with 10 weight oil, regulator wide open and no downstream restrictions.

Part No.	Inlet Fluid Test Pressure	Inlet/Outlet Size	Fluid Flow
233760 234266	5000 psi (36 MPa, 360 bar)	3/4 BSPP(F) 3/4 npt(F)	11.3 gpm (42.9 lpm)
233767 234264	3000 psi (21 MPa, 210 bar)	3/8 BSPP(F) 3/8npt(F)	8.2 gpm (31.2 lpm)
233768 234265	3660 psi (25 MPa, 256 bar)	3/8 BSPP(F) 3/8npt(F)	9.2 gpm (35.0 lpm)
233769 234270	4000 psi (28 MPa, 280 bar)	3/4 BSPP(F) 3/4npt(F)	11.7 gpm (44.5 lpm)
233770 234271	3800 psi (26 MPa, 266 bar)	3/4 BSPP(F) 3/4npt(F)	12.3 gpm (46.7 lpm)
233771 234268	2500 psi (17 MPa, 170 bar)	3/8 BSPP(F) 3/8npt(F)	10.2 gpm (38.8 lpm)
233772 234269	3400 psi (23.5 MPa, 235 bar)	3/8 BSPP(F) 3/8npt(F)	13.1 gpm (49.8 lpm)
233813 234259	3800 psi (26 MPa, 266 bar)	3/8 BSPP(F) 3/8npt(F)	10.6 gpm (40.3 lpm)
233814 234260	2500 psi (17 MPa, 170 bar)	3/8 BSPP(F) 3/8npt(F)	8.1 gpm (30.8 lpm)

Mounting Dimensions

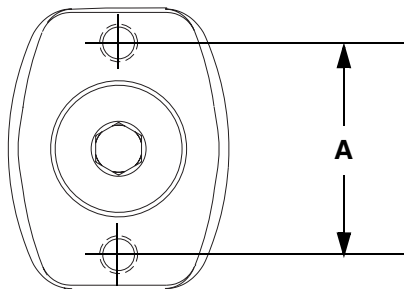

Part No.	Thread	Dimension A
233760 234266	M6	36 mm (1.42 in.)
233767 234264	M5	28 mm (1.10 in.)

Part No.	Thread	Dimension A
233768 234265	M5	28 mm (1.10 in.)
233769 234270	M6	36 mm (1.42 in.)
233770 234271	M6	36 mm (1.42 in.)
233771 234268	M5	28 mm (1.10 in.)
233772 234269	M5	28 mm (1.10 in.)
233813 234259	M5	28 mm (1.10 in.)
233814 234260	M5	28 mm (1.10 in.)

Graco Warranty

Graco warrants all equipment referenced in this document which is manufactured by Graco and bearing its name to be free from defects in material and workmanship on the date of sale to the original purchaser for use. With the exception of any special, extended, or limited warranty published by Graco, Graco will, for a period of twelve months from the date of sale, repair or replace any part of the equipment determined by Graco to be defective. This warranty applies only when the equipment is installed, operated and maintained in accordance with Graco's written recommendations.

This warranty does not cover, and Graco shall not be liable for general wear and tear, or any malfunction, damage or wear caused by faulty installation, misapplication, abrasion, corrosion, inadequate or improper maintenance, negligence, accident, tampering, or substitution of non-Graco component parts. Nor shall Graco be liable for malfunction, damage or wear caused by the incompatibility of Graco equipment with structures, accessories, equipment or materials not supplied by Graco, or the improper design, manufacture, installation, operation or maintenance of structures, accessories, equipment or materials not supplied by Graco.

This warranty is conditioned upon the prepaid return of the equipment claimed to be defective to an authorized Graco distributor for verification of the claimed defect. If the claimed defect is verified, Graco will repair or replace free of charge any defective parts. The equipment will be returned to the original purchaser transportation prepaid. If inspection of the equipment does not disclose any defect in material or workmanship, repairs will be made at a reasonable charge, which charges may include the costs of parts, labor, and transportation.

THIS WARRANTY IS EXCLUSIVE, AND IS IN LIEU OF ANY OTHER WARRANTIES, EXPRESS OR IMPLIED, INCLUDING BUT NOT LIMITED TO WARRANTY OF MERCHANTABILITY OR WARRANTY OF FITNESS FOR A PARTICULAR PURPOSE.

Graco's sole obligation and buyer's sole remedy for any breach of warranty shall be as set forth above. The buyer agrees that no other remedy (including, but not limited to, incidental or consequential damages for lost profits, lost sales, injury to person or property, or any other incidental or consequential loss) shall be available. Any action for breach of warranty must be brought within two (2) years of the date of sale.

GRACO MAKES NO WARRANTY, AND DISCLAIMS ALL IMPLIED WARRANTIES OF MERCHANTABILITY AND FITNESS FOR A PARTICULAR PURPOSE, IN CONNECTION WITH ACCESSORIES, EQUIPMENT, MATERIALS OR COMPONENTS SOLD BUT NOT MANUFACTURED BY GRACO. These items sold, but not manufactured by Graco (such as electric motors, switches, hose, etc.), are subject to the warranty, if any, of their manufacturer. Graco will provide purchaser with reasonable assistance in making any claim for breach of these warranties.

In no event will Graco be liable for indirect, incidental, special or consequential damages resulting from Graco supplying equipment hereunder, or the furnishing, performance, or use of any products or other goods sold hereto, whether due to a breach of contract, breach of warranty, the negligence of Graco, or otherwise.

FOR GRACO CANADA CUSTOMERS

The Parties acknowledge that they have required that the present document, as well as all documents, notices and legal proceedings entered into, given or instituted pursuant hereto or relating directly or indirectly hereto, be drawn up in English. Les parties reconnaissent avoir convenu que la rédaction du présente document sera en Anglais, ainsi que tous documents, avis et procédures judiciaires exécutés, donnés ou intentés, à la suite de ou en rapport, directement ou indirectement, avec les procédures concernées.

Graco Information

TO PLACE AN ORDER, contact your Graco distributor, or call this number to identify the distributor closest to you:

1-800-328-0211 Toll Free

612-623-6921

612-378-3505 Fax

*All written and visual data contained in this document reflects the latest product information available at the time of publication.
Graco reserves the right to make changes at any time without notice.*

This manual contains English. MM 309475

Graco Headquarters: Minneapolis

International Offices: Belgium, China, Japan, Korea

GRACO INC. P.O. BOX 1441 MINNEAPOLIS, MN 55440-1441

Copyright 2002, Graco Inc. is registered to ISO 9001

www.graco.com

Revised 2/2009